

155

REPAIR MANUAL

- **MECHANICAL UNITS**
- **BODY**

Alfa Romeo 

THE UNIVERSITY OF CHICAGO LIBRARY
540 EAST 57TH STREET
CHICAGO, ILLINOIS 60637

1. TITLE: *THE UNIVERSITY OF CHICAGO LIBRARY*
2. AUTHOR: *UNIVERSITY OF CHICAGO LIBRARY*
3. SUBJECT: *LIBRARY*

4. PUBLICATION DATE: *1968*
5. PUBLISHER: *UNIVERSITY OF CHICAGO LIBRARY*
6. DISTRIBUTION STATEMENT: *UNIVERSITY OF CHICAGO LIBRARY*

7. AVAILABILITY STATEMENT: *UNIVERSITY OF CHICAGO LIBRARY*
8. SECURITY CLASSIFICATION: *UNIVERSITY OF CHICAGO LIBRARY*

9. PRICE STATEMENT: *UNIVERSITY OF CHICAGO LIBRARY*
10. STATEMENT OF WORKS COVERED: *UNIVERSITY OF CHICAGO LIBRARY*

11. DISTRIBUTION STATEMENT: *UNIVERSITY OF CHICAGO LIBRARY*

INTRODUCTION

This publication provides the information necessary for the maintenance and repair operations regarding the **155** for the models listed in the "vehicle identification" table. The aim of this publication is to provide the Alfa Romeo Service staff with a tool which can be used to rapidly identify any faults and help to render the intervention precise and efficient.

The manual shows the procedures relative to the removal and refitting operations, disassembly and checks regarding the various groups which form the vehicle. The procedures are illustrated in detail as is the use of any necessary tools. A system of symbols combined with the basic technical data given to one side of each drawing facilitate a rapid and complete consultation of the manual.

Particular attention has been given to the fault diagnosis procedures which can be found at the end of each group. These combine with the irreplaceable experience of the operator and help to correctly identify and rectify the fault starting from the malfunction which the operator himself has detected and carrying out a series of tests on the system affected by the fault.

For the information relative to the vehicle's electrical system the "155 - Repair Manual - Electrical-Electronics Diagnosis" manual should be consulted.

All the information contained in this manual is accurate to the date of publication.

Alfa Romeo reserves the right to carry out any modifications to its products considered necessary without warning, though the technical information and up-dates regarding this manual will be promptly published.

How to use this manual

This manual is divided into chapters (GROUPS) relative to each of the assemblies which make up the vehicle.

To rapidly identify the group required, refer to the initial index.

Each group is accompanied by an analytic index and an illustrated index in order to facilitate the search for the required subject.

A brief description of the "removal/refitting", "disassembly/reassembly" and "checking and adjustment" procedures follows.



















The procedures show the complete disassembly of the components and should be carried out alone only when strictly necessary. The "reassembly" and "refitting" procedures are normally a simple reversal of the "disassembly" and "removal" procedures and only the reassembly procedures which are significantly different are illustrated.



















The technical data, specific tools and fault diagnosis procedures follow the procedures mentioned above.

Symbols

This manual employs a series of symbols in order for the main technical information provided to be easily located.

The list of the symbols follows.

	removal/disassembly	
	refitting/reassembly	
	Tighten to the torque	
	Rivet nut	
	adjustment/regulation	
	visual check	
	lubricate	
	weight difference	
	angular value	
	pressure	
	temperature	
	Bleed air from brake system	
	surface to be treated	
	interference	
	play	
	intake	

	exhaust
	lubricate with engine oil
	left-hand thread
	tightening torque in oil
	engine idle speed
	ovalization
	taper
	eccentricity
	flatness
	diameter
	linear dimension
	parallelism
	top-up with grease
	heating temperature
	seal
	top-up with engine oil
	grease
	WARNING!
	CAUTION!

Indications for the operators

All the operations must be carried out with the greatest care in order to avoid damaging vehicles and persons.

- For some procedures the use of the Alfa Romeo specific tools is indicated. The use of these tools is indispensable to the safety of the operation and to avoid damage to the parts involved in the procedure.
- To detach adhering parts, lightly tap with an aluminium or lead mallet; for parts in metal and a wooden or resin mallet for parts in light alloy.
- When disassembling check that the necessary parts have been marked.
- If necessary when refitting, lubricate the parts to prevent seizing or binding during the initial stages of operation.
- Using adhesive tape or clean rags, protect the parts which, after disassembly may allow dust or foreign particles to enter the engine.
- When refitting it is vital that the tightening torques and regulation settings are respected.
- During removal substitute the seal rings, oil seals, flexible washers, safety plates, self locking nuts and any other part showing signs of wear.
- Avoid marking the fittings inside the vehicle.

Assemblies or detached parts must only be replaced by original spare parts as only in this way can the suitability of the part and its perfect operation be guaranteed.

- **CAUTION** and **WARNING** indicate those procedures which must be carried out with particular care in order to prevent personal injury or damage to the vehicles.

**WARNING:**

is used when lack of care may cause personal injury.

**CAUTION:**

is used when lack of care may cause damage to the vehicle or parts of it.

- Obey the current safety regulations regarding operation in the workshop. Where necessary specific precautions have been given in the manual in order to prevent dangerous situations from arising.

NOTE:

It is possible that some subjects have not been covered in time for publication.

In the indexes to the individual groups these subjects are indicated however and are accompanied by the words "Due for publication".

The Technical Assistance will provide documentation relative to these subjects in the form of up-date sheets or in "Technical Bulletins" which will promptly be sent to the Alfa Romeo Assistance Network.

NOTE:

It should be pointed out that inside this manual the "155" vehicle may also be indicated with the "167" vehicle code.

VEHICLE IDENTIFICATION IDENTIFICATION LABELS

TWIN SPARK ENGINES

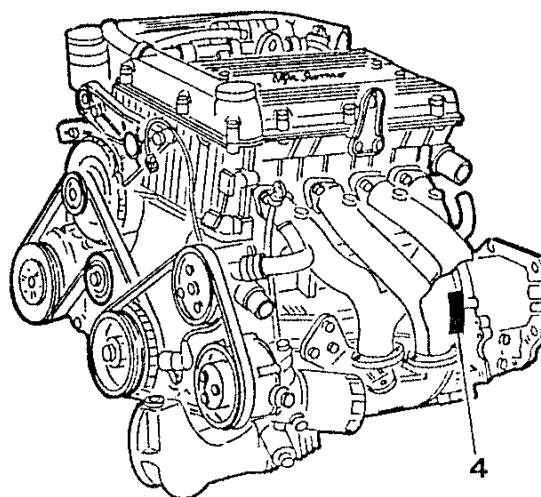
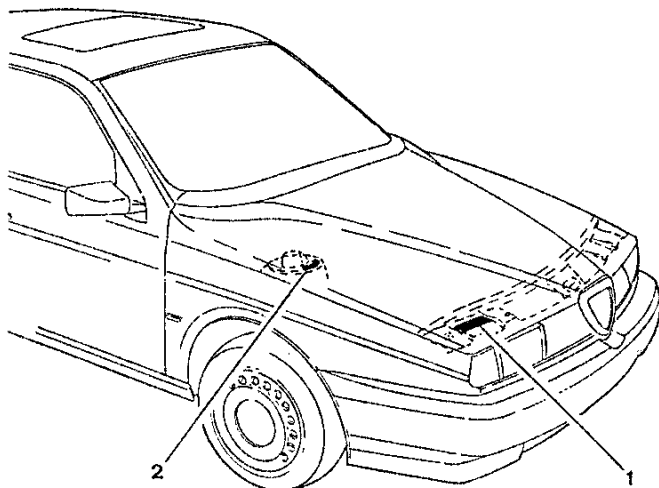

V6 ENGINE

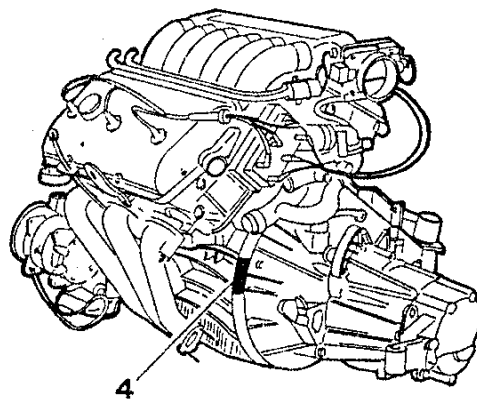
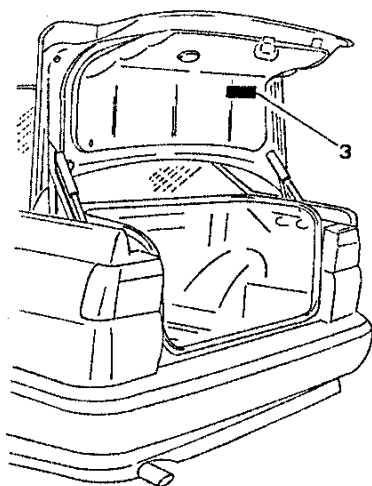

1. Label carrying identification data
2. Body label
3. Body paint identification label
4. Engine label

MODEL IDENTIFICATION TABLE

Vehicle		155			
Model		T.SPARK 1.8	T.SPARK 1.8	T.SPARK 2.0	V6
Cubic capacity		1.749 cm ³	1.773 cm ³	1.995 cm ³	2.492 cm ³
Type		4-door sedan			
LH/RH Drive		LH + RH	LH + RH	LH + RH	LH + RH
Vehicle type n°	on identification label	167A4B	167A4A	167A2A	167A1
	on the upper part of the RH wing, engine compartment	167.000	167.000	167.000	167.000
Engine series n°		AR67103 from 000.001	AR67102 from 000.001	AR67202 from 000.001	AR67301 from 000.001

NOTE: the various models are indicated in the manual by the following symbols:

- "T.SPARK 1.8" and "T.SPARK 2.0" are indicated by "1.8-2.0 T.S."
- "V6" is indicated by "2.4 V6".